

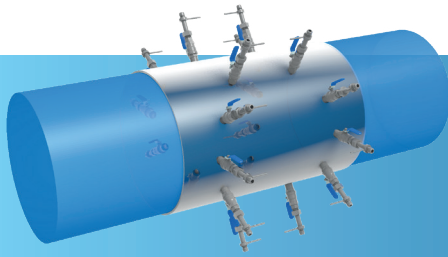

Water



**GWF**



# Ductus S

Stationary time of flight flow meter  
for pressurized pipes

## Your benefits

- Up to 10 acoustic measurement paths:  
**Exceptional accuracy, repeatability and linearity over the entire measurement range**
- Complete installation flexibility:  
**Reliable results independent of installation conditions. No straight runs necessary even with 90° elbows, valves or pumps (swirl)**
- Patented velocity profile correction:  
**No need for flow straighteners or time consuming on-site calibration**
- Measurement of lowest flows:  
**Exact balancing, fast detection of network losses and in-depth understanding of operational processes**
- Clamp-On option available:  
**Easy and non-intrusive mounting without process interruption guarantees minimal installation costs**

## Application

- Pressurized pipes 100-5000 mm (4-200") in diameter
- Suitable for sites with difficult installation settings, e.g. pumps, valves or 90° elbows
- Ideal for applications with non-uniform (swirl), rapidly changing or close to zero flow conditions
- Permanent flow monitoring for applications in clean water:
  - Water distribution networks
  - Reservoir monitoring
  - Hydropower plants
  - Industry

## Features

- ABS wall-mounted transmitter, IP65 (NEMA 4)
- Wetted sensors: Feedthrough or from the inside of the pipe
- Enables measurement of turbine and pump efficiency compliant with IEC 60041 and ASME PTC 18
- Dry sensors: Clamp-On for easy installation, compliant with ISO12242
- Time of flight technology with digital signal processing
- Measurement in multiple planes with single or crossed paths
- U0/D0, no need for flow conditioners or on-site calibration
- Bi-directional measurement over the entire flow range
- Accuracy up to  $\pm 0.15\%$  of measured flow value
- Zero stability  $< 1$  mm/s, Repeatability  $< \pm 0.02\%$
- Measurement of low velocities down to 1.5 mm/s
- Integrated Wi-Fi access point
- Graphical user interface in multiple languages
- All units for display and data storage can be customized by the user
- Communication: RS-485, Modbus RTU/TCP, Ethernet, optional 4G/3G/2G
- Power supply: 9-36 V DC or 85-260 V AC (50/60 Hz)
- Internal data storage 16 GB

## Options

- Feedthrough sensors if pipe can be dewatered for installation
- Internal mount sensors if pipe is accessible only from the inside
- Clamp-On sensors for non-intrusive flow measurement
- 1 to 10 acoustic measurement paths

# Product description

---

Ductus S is a time of flight system designed for highly accurate flow measurement in water distribution networks and hydropower plants.

Flow monitoring is very often mandatory in the area of water supply and industry. Quite frequently, the pipe systems are complex and contain valves and pumps. Due to the patented velocity profile compensation of GWF's Ductus S, no flow straighteners or on-site calibration are required. The unique digital signal processing allows the detection of even the smallest time differences, i.e. even the smallest amounts are determined accurately.

## WebUI (Wi-Fi)

---

Ductus S is equipped with an integrated web server running a WebUI. You can display and manage the WebUI using the standard web browser of your smartphone, tablet PC or notebook. There is no need for any additional software or App. Parameter setting and data visualization has never been so easy.



## Transducer replacement

---

In the unlikely event that a transducer should fail, Ductus S can be programmed to automatically compensate for the loss in path information with little reduced accuracy. Additionally, the operator is advised that an alarm is present.

The feedthrough transducer housings are separate from the transducers, and are designed to allow removal of the entire transducer for repair, replacement or cleaning without the need to dewater the pipe or shut down the process.

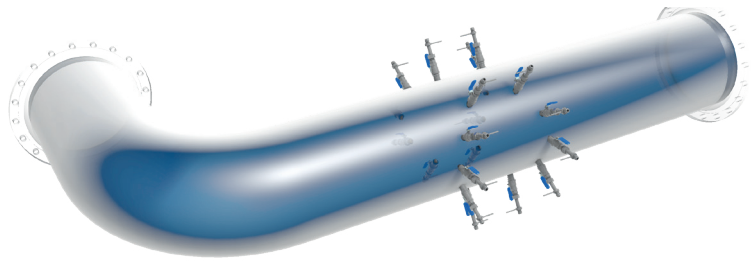

Ductus S installed after a 90° elbow

Ductus S is a fully integrated metering solution with up to 10 acoustic paths for liquid fluids. It increases your profitability with exceptional repeatability and linearity throughout the flow range.

## Measuring principle

---

Space constraints and application configurations lead to complex flows in pipes which contain elbows, tees or other disturbing and non-uniform elements. This leads to difficulties in installing flow meters at an optimum location; which is defined by a minimum distance upstream or downstream of known disturbances at which a fully developed velocity profile is present. For traditional flow meters, significant errors may be caused by these adverse installation conditions.

In contrast to conventional systems, Ductus S provides detailed information on the flow velocity profile. An accurate measurement of the flow rate can be achieved by replicating the flow velocity profile across the pipe. Accuracy is maximized using predetermined conduit configuration parameters and correction factors, which incorporate the specific local installation conditions.

Conventional flow meters are also sensitive to velocity profiles with a large rotational component (swirl). Swirl can be caused by pumps or multiple out-of-plane changes in flow direction. It is present to some extent in almost every application and can generate significant transverse velocity components; and it takes a long distance to dissipate. If the swirl is not accounted for, it can cause significant errors. Ductus S can quantify and correct these disrupting factors without difficulty. The Ductus S system keeps its measurement accuracy even when asymmetric profiles and swirls are present in the flow.

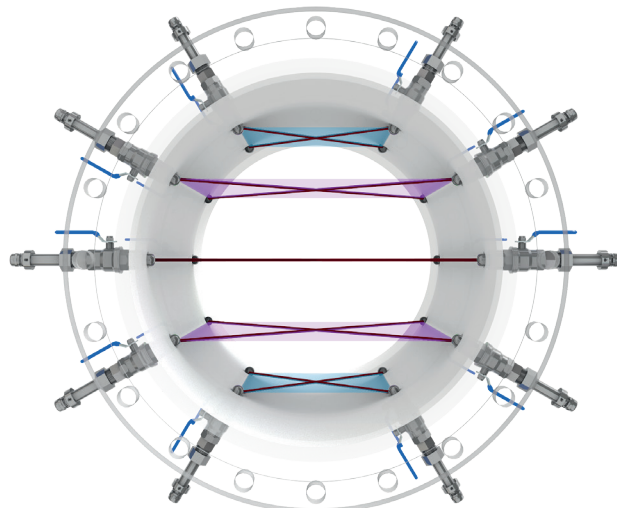

# Component description

---

The Ductus S system is composed of a wall-mounted transmitter and several sensor options. For non-intrusive measurement, Clamp-On transducers are available. If the pipe can be dewatered for installation, feedthrough or internally mounted sensors are suitable options.

## Transmitter

---

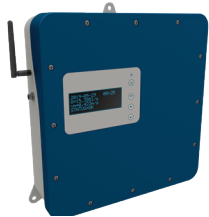

Wall-mounted transmitter

The Ductus S transmitter incorporates all the required algorithms and software to ensure measurement accuracy and repeatability. The IP65 (NEMA 4X) ABS housing features a 4 x 20 alphanumeric LCD display and a 4 button keypad.

All configuration data as well as measured and calculated data are stored inside a 16 GB MicroSD card. The transmitter controls the measurements, calculates the flow rate and provides freely programmable current outputs, status alarms, frequency outputs and totalizer readings.

## Clamp-On transducers

---



CO-L, Clamp-On sensor 200 kHz



CO-S, Clamp-On sensor 1 MHz

When combining the Ductus S with Clamp-On transducers, the flow measurement becomes non-intrusive. The transducers are installed with little technical effort and without process interruption on the pipeline.

Clamp-On transducers require no modification of the conduit or plant shutdown. Once the sensors have been installed, they can easily be removed from the mounting system, for example to renew the coupling paste. This prevents a shift of the installation position.

## Wetted sensors

---



FT-S, FT-M and FT-L feedthrough sensors

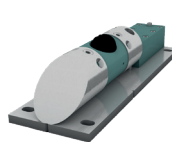

Internal mount sensor TD-IM

Depending on your individual requirements, several options of feedthrough sensors are available. For the sensors of type FT-S and FT-M, the pipe only needs to be dewatered for the initial installation. Removal of these sensors for cleaning, repair or replacement is possible without process interruption.

If the pipe is accessible only from the inside, internally mounted sensors are a suitable option.

---

# Technical Data

## Transmitter

## Ductus S

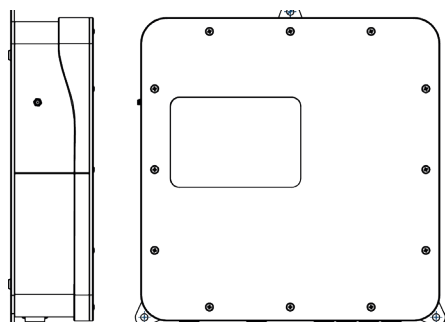

<b>Acoustic paths</b>	1 to 10 (more upon request)
<b>Range</b>	0 to ± 20 m/s (bidirectional)
<b>Accuracy Q</b>	up to ± 0.15 % (10 paths)
<b>Repeatability</b>	< ± 0.02 %
<b>Zero stability</b>	< 1 mm/s
<b>Display / Keyboard</b>	4 lines, 20 characters / 4 keys
<b>Data logger</b>	16 GB MicroSD card
<b>Communication</b>	RS-485, Modbus RTU/TCP, Wireless LAN, Ethernet 10/100 Mbps, 4G (LTE) / 3G (HSPA+) / 2G
<b>Inputs</b>	max. 4 x 4-20 mA, 2 x digital
<b>Outputs</b>	max. 4 x 4-20 mA, 4 x Relay, 2 x Pulse
<b>Power supply</b>	9-36 V DC or 85-260 V AC (50/60 Hz)
<b>Approval</b>	IP65 (NEMA 4)
<b>Enclosure</b>	ABS, wall mounted
<b>Dimensions</b>	338 mm x 333 mm x 92 mm (L x W x H)



## Wetted sensors

### FT-S

### FT-M

### FT-L1000

### TD-IM

<b>Frequency</b>	1 MHz	1 MHz	1 MHz	200 kHz
<b>Beam width</b>	5° (-3 dB)	10° (-3 dB)	10° (-3 dB)	18° (-3 dB)
<b>Configuration</b>	IEC41 / ASME PTC 18	n.a.	IEC41 / ASME PTC 18	IEC41 / ASME PTC 18
<b>Pipe diameter</b>	0.1 m to 2 m	0.1 m to 4 m	0.3 m to 5 m	1.0 m to 10 m
<b>Mounting</b>	welding socket or thread	welding socket or thread	welding socket or thread	- n.a.
<b>Pressure rate</b>	20 bar *)	20 bar *)	60 bar *)	60 bar *)
<b>Material</b>	stainless steel	stainless steel	stainless steel	stainless steel / polyamide
<b>Cable</b>	twisted pair with shield	twisted pair with shield	twisted pair with shield	twisted pair with shield
<b>Operating temperature</b>	0 °C to 40 °C	0 °C to 40 °C	0 °C to 40 °C	0 °C to 40 °C
<b>Dimensions</b>	Ø 1", length: 293 mm	Ø 1 1/2", length: 407 mm	Ø 1 1/2", length: 186 mm	320 x 100 x 70 mm (L x W x H)
<b>Installation</b>	incl. fixing device, ball valve and welding socket	to be used in combination with 1 1/2" ball valve and NPT inner thread	removal of the transducer for repair, replacement or cleaning by means of a special jacking tool.	from the inside

\*) other ranges upon request

## Clamp-On transducers

### CO-L

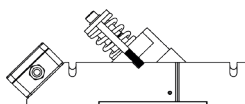

### CO-S



<b>Pipe diameter</b>	0.4 m to 15 m	0.025 m to 1 m
<b>Pipe wall thickness</b>	up to 100 mm (steel, plastic, glass fiber)	up to 25 mm
<b>Frequency</b>	200 kHz	1 MHz
<b>Beam width</b>	8° (-3 dB)	5°
<b>Material</b>	stainless steel, polyamide	zinc alloy
<b>Operating temperature</b>	-20 °C to 60 °C	-20 °C to 60 °C
<b>Dimensions</b>	270 x 115 x 100 mm (L x W x H)	56 x 32 x 25 mm (L x W x H)

### Headquarter

GWF MessSysteme AG  
Obergrundstrasse 119  
6005 Lucerne, Switzerland

T +41 41 319 50 50  
F +41 41 310 60 87  
info@gwf.ch, www.gwf.ch

### Sales

GWF Technologies GmbH  
Gewerbstraße 46f  
87600 Kaufbeuren, Germany

T +49 8341-959990  
info@gwf-technologies.de  
www.gwf-technologies.de

printed in  
switzerland

Subject to modification, 10.01.2020 – EPe60105